



The New Mercedes-Benz eSprinter.

Electric Panel Van model.

Prices effective from February 2025.

Mercedes-Benz





RETURN TO START



Contents

> Summary	3
> Standard equipment highlights	4
> MBUX	5
> The eSprinter PRO	6
> The eSprinter SELECT	7
> List price summary	8
> Mercedes-Benz Finance Options	9
> Equipment overview	10
> Colours and upholstery	19
> Charging information	21
> Technical data	22
> Mercedes-Benz Vans and the environment	28
> The Mercedes-Benz App	29
> Approved Used	30
> Integrated Service Package (ISP)	31
> Service 24: Demand more	32

Please note

This document provides information about the model range line-up and specifications of the eSprinter. It also contains key details about options, economy and performance of variants. Details are correct at time of publication and are subject to revision without notice. Any images used in this document may not reflect UK specification and are for illustrative purposes only. Images may show optional equipment which does not form part of UK standard specification.

The New eSprinter Summary.



RETURN TO START

2 Vehicle types	Panel Van & Chassis	1 Charging Configuration	AC: 11kW and 22kW with DC: 115kW**
2 Battery sizes	81kWh & 113kWh	2 Vehicle lengths	L2 & L3
2 Motors	100kW & 150kW	2 Trim levels	PRO or SELECT



81/113kWh Panel Van



81/113kWh Chassis



Multi-function steering wheel.



CCS rapid charging port, 115kW max. capacity.



MBUX Navigation and Live Traffic Information.

All-electric WLTP combined range, full charge
161 - 272 miles*

80% charge top-up in just
34-42 minutes*

*81kWh 314 Van L3 - 113kWh 414 Van L3 variant

Electrical WLTP range for the eSprinter 81kWh - 113kWh battery range in miles (km): 161 (259) - 272 (438). Electrical consumption in kWh/100 km: 28.0 - 34.6. Combined CO₂ emissions in g/km: 0. Figures correct as of February 2025. The indicated values were determined according to the prescribed measurement method - Worldwide Harmonised Light Vehicle Test Procedure (WLTP). Battery Electric Vehicles (BEV) require mains electricity for charging, range figures determined with the battery fully charged. Figures shown are for comparability purposes; only compare with other cars tested to the same technical procedure (WLTP). Figures may not reflect real life driving results, which will depend upon a number of factors including the starting charge of the battery, factory-fitted options, accessories fitted (post registration), variations in weather, driving styles and vehicle load. Further information about the test used to establish range, power consumption and CO₂ figures can be found at <http://www.mercedes-benz.co.uk/WLTP>. For real time data visit https://voc.mercedes-benz.com/voc/gb_en. **Charging times are subject to the power available at the location where the vehicle will be charged as well as external factors such as temperature and type of cable and charger used.

Standard Equipment Highlights.



RETURN TO START

The Mercedes-Benz eSprinter combines the very best of safety, efficiency and connectivity. All eSprinter models include:

Active Brake Assist with pedestrian and cyclist detection. The system helps to prevent rear-end collisions. Active Brake Assist can help you to prevent accidents (with vehicles driving in front, with crossing pedestrians or cyclists) or to minimise their consequences.

Attention Assist drowsiness detection. Can help to avoid momentary nodding off and therefore provides you with increased safety, in particular when driving at night and on long journeys. The system provides you with a visual and audible warning if it identifies typical signs of fatigue or attention lapses, and suggests taking a break.

Acoustic Presence Indicator All our electric vehicles come as standard with an external acoustic warning to alert pedestrians or cyclists at speeds under 19 mph.

Crosswind Assist detects strong crosswinds and helps the driver to remain in their lane by autonomous targeted braking intervention.

MBUX Multimedia System with 10.25" Touchscreen The state-of-the-art infotainment system has increased computing power, improved functionality in controlling vehicle functions, greater comfort and better compatibility with mobile devices.

Driving programs Drivers can choose between 3 different driving programs: Maximum range, Economic and Comfort. The programs control engine power, engine torque and climate control.

Reverse Camera the camera assists when parking and manoeuvring: it displays the area behind the vehicle. Damage can be avoided and pedestrians spotted more easily. Dynamic guidelines and a 180° view also facilitate orientation when reversing.

The Mercedes-Benz App services Assists the driver with pre-conditioning, finding a charge point and much more.

Emergency Call System can ensure crucial time savings in an emergency. Using a communication module with its own SIM card, an automatic emergency call is initiated following an accident, thereby potentially reducing the time before the emergency services arrive at the scene. GPS information can be sent if the driver is unresponsive. The emergency call can also be initiated manually in order to request help.

Blind Spot Assist Helps when changing lanes and reversing. If a vehicle is detected, a warning sign in a red triangle appears in the corresponding exterior mirror.

Intelligent Speed Assist Displays the current speed limit in the driver's direct field of vision in the instrument cluster.

Active Lane Keeping Assist protects against unintentional lane departure. If the system's camera detects a lane departure, a corrective steering intervention takes place to guide the vehicle back into the lane. If the driver fails to react and the vehicle crosses the lane markings, an additional haptic warning occurs (pulsed vibration via the steering wheel).



Illustration of Active Lane Keeping Assist.



RETURN TO START

MBUX – the Mercedes-Benz User Experience infotainment system.

The state-of-the-art MBUX technology comes with a high resolution 10.25" touchscreen fitted as standard, offering intuitive touch control and a wealth of features.

With the latest software, all eSprinter-specific settings, such as charging, pre-conditioning or navigation with **Electric Intelligence**, can now be made not only via the instrument cluster, but also via the touchscreen or voice assistant.

Standard features

- High-resolution 10.25-inch touchscreen
- AM/FM radio with dual tuner
- DAB radio
- Bluetooth connectivity with audio streaming
- LINGUATRONIC voice control with optimised, intuitive voice assistant
- Seat-related voice recognition for driver and front passenger³
- Extensive personalization options with up to seven profiles²
- Over-the-air (OTA) updates²
- Wi-Fi hotspot
- Wireless remote UI connection for e.g. Apple CarPlay and Android Auto⁴
- Online music^{1,2}: Tidal, Amazon Music, Spotify
- Multimedia interface with three backlit 18W PPS USB-C ports
- 2-way front speakers
- Volume settings for audio and phone
- Centre-fill speakers for improved sound quality and voice output
- Digital instruction manual

1 Service Entertainment Package required

2 via The Mercedes-Benz App

3 only together with comfort overhead control panel

4 Apple CarPlay and Android Auto is only available in conjunction with E4S – Smartphone integration package





RETURN TO START

The eSprinter PRO model.

Standard features for the eSprinter PRO include:

Exterior

- Exterior mirror heated and electr. adjustable
- Steel wheels 6.5 J x 16"
- Rear door step

Interior

- Multifunction steering wheel
- Height and rake adjustable steering wheel
- Instrument cluster with colour display
- Heated seat for driver
- Armrest for driver's seat
- Co-driver's double seat
- Pre-entry climate control
- TEMPOMATIC Air conditioning
- Electrical parking brake
- USB socket, 5 V
- Maturin black fabric

Load area

- Full-length partition
- Double-wing rear doors, opening to side wall
- Wood flooring
- Rear cab wall lining
- Towing eye rear

Technology & Charging

- MBUX multimedia system
- Digital radio (DAB)
- Acoustic package
- Pre-installation: Remote and Navigation Services
- Pre-installation: Remote and Charging Services Premium
- AC charging 11kW /22kW & DC charging 115kW
- 8m charging cable, mode 3 (type 2, 3x32A)
- Smartphone integration package

Safety & Driver Assistance

- Active Brake Assist
- Hill-Start Assist
- Blind Spot Assist
- Crosswind Assist
- Active Lane Keeping Assist
- ATTENTION ASSIST
- Sideguard Assist
- Intelligent Speed Assistant
- Cruise control
- Tyre pressure monitoring front and rear
- Breakdown management
- Reversing camera
- Rain sensor
- Alarm and double locks



Government OZEV grant of up to £5,000

The eSprinter is eligible for a Government OZEV grant that gives businesses 35% off the purchase price, up to a maximum of £5,000*.



Basic recommended list price (ex.VAT) for the 81kWh eSprinter 314 Van L3 PRO

£58,740

➤ Arrange a test drive at your nearest Dealership

* Vehicle purchase price is calculated on base vehicle only (excluding any optional equipment), it excludes delivery charges and first registration fee. The grant will be applied after any vehicle discount has been offered and includes VAT and number plate costs. For more information, visit: <https://www.gov.uk/plug-in-car-van-grants>

The eSprinter SELECT model.



RETURN TO START

Upgrade from PRO to SELECT to get all of the additional equipment listed below:

Exterior

- Front & rear mud flaps

Interior

- Leather steering wheel
- Comfort driver's seat
- Lumbar support for driver's seat
- Convenience head restraint for driver's seat
- Cup holders in front
- Hinged lid for stowage compartment

Technology & Charging

- Charging package, dashboard
- Highbeam Assist
- LED High Performance headlamps



Government OZEV grant of up to £5,000

The eSprinter is eligible for a Government OZEV grant that gives businesses 35% off the purchase price, up to a maximum of £5,000*.



Basic recommended list price (ex.VAT) for the 81kWh eSprinter 320 Van L3 SELECT

£62,570



▶ Arrange a test drive at your nearest Dealership

* Vehicle purchase price is calculated on base vehicle only (excluding any optional equipment), it excludes delivery charges and first registration fee. The grant will be applied after any vehicle discount has been offered and includes VAT and number plate costs. For more information, visit: <https://www.gov.uk/plug-in-car-van-grants>

List Price Summary.



RETURN TO START

Vehicle Model Description	Powertrain	CO ₂ emissions, WLTP	Basic Recommended Retail Price (Ex. VAT)	Total Recommended Retail Price (Inc. VAT)
81kWh eSprinter 314 Van L2 PRO	Battery electric vehicle, RWD, 100kW Motor, Electric range 165 miles ¹ WLTP combined	0g/km	£59,915	£71,898
81kWh eSprinter 320 Van L2 PRO	Battery electric vehicle, RWD, 150kW Motor, Electric range 167 miles ¹ WLTP combined	0g/km	£61,055	£73,266
81kWh eSprinter 320 Van L2 SELECT	Battery electric vehicle, RWD, 150kW Motor, Electric range 167 miles ¹ WLTP combined	0g/km	£63,750	£76,500
81kWh eSprinter 314 Van L3 PRO	Battery electric vehicle, RWD, 100kW Motor, Electric range 161 miles ¹ WLTP combined	0g/km	£58,740	£70,488
81kWh eSprinter 320 Van L3 PRO	Battery electric vehicle, RWD, 150kW Motor, Electric range 162 miles ¹ WLTP combined	0g/km	£59,880	£71,856
81kWh eSprinter 320 Van L3 SELECT	Battery electric vehicle, RWD, 150kW Motor, Electric range 161 miles ¹ WLTP combined	0g/km	£62,570	£75,084
81kWh eSprinter 414 Van L2 PRO	Battery electric vehicle, RWD, 100kW Motor, Electric range 183 miles ¹ WLTP combined	0g/km	£61,795	£74,154
81kWh eSprinter 420 Van L2 PRO	Battery electric vehicle, RWD, 150kW Motor, Electric range 185 miles ¹ WLTP combined	0g/km	£62,935	£75,522
81kWh eSprinter 414 Van L3 PRO	Battery electric vehicle, RWD, 100kW Motor, Electric range 177 miles ¹ WLTP combined	0g/km	£60,605	£72,726
81kWh eSprinter 420 Van L3 PRO	Battery electric vehicle, RWD, 150kW Motor, Electric range 178 miles ¹ WLTP combined	0g/km	£61,745	£74,094
113kWh eSprinter 414 Van L3 PRO	Battery electric vehicle, RWD, 100kW Motor, Electric range 272 miles ¹ WLTP combined	0g/km	£73,260	£87,912
113kWh eSprinter 420 Van L3 PRO	Battery electric vehicle, RWD, 150kW Motor, Electric range 269 miles ¹ WLTP combined	0g/km	£74,230	£89,076
113kWh eSprinter 420 Van L3 SELECT	Battery electric vehicle, RWD, 150kW Motor, Electric range 268 miles ¹ WLTP combined	0g/km	£76,920	£92,304

† Technical data of the eSprinter in this publication are preliminary values and were determined internally in accordance with the WLTP certification methods. There are currently no confirmed values from TÜV, nor is there an EC type approval or a certificate of conformity with official values. Deviations between this data and the official values are possible. UK range figures may vary and these will be published when available.

Government OZEV grant of up to £5,000

The eSprinter is eligible for a Government OZEV grant that gives businesses 35% off the purchase price, up to a maximum of £5,000*.



* Vehicle purchase price is calculated on base vehicle only (excluding any optional equipment), it excludes delivery charges and first registration fee. The grant will be applied after any vehicle discount has been offered and includes VAT and number plate costs. For more information, visit: <https://www.gov.uk/plug-in-car-van-grants>

This document is for guidance only and must be used in conjunction with a configuration tool prior to final specification decisions and vehicle quotations being prepared and accepted. List prices are quoted ex-factory unless otherwise stated. Delivery charges excluding VAT will be added to model prices quoted in this document. Prices based on standard finish paint choice. Mercedes-Benz Vans UK and authorised Dealers reserve the right to alter specification and vary prices without notice. The availability of options may depend on the chosen base vehicle and other optional equipment specified, and should be confirmed with your Mercedes-Benz Vans Dealer prior to order placement. VAT is calculated at the standard rate of 20%. Mercedes-Benz Vans UK Ltd, Tongwell, Milton Keynes MK15 8BA.



RETURN TO START

Mercedes-Benz Finance Options.

Choose an agreement that suits you with Mercedes-Benz Finance.

At Mercedes-Benz Finance we understand what it takes to run a modern-day business. Because of this, we have a number of finance options ready to suit your business needs.

Agility (Personal Contract Plan)

Agility (Personal Contract Plan) is our most flexible method of financing. You drive the vehicle over a fixed term, with fixed monthly payments. And at the end of the agreement, you decide whether you want to:

- Buy another Mercedes-Benz.
- Purchase your van by paying the Optional Purchase payment (balloon) and Option to Purchase Fee.
- Return it to us.

As a business customer, your vehicle can also appear as an asset on your balance sheet.

[For more information about Agility.](#)

Hire Purchase

A straightforward route to ownership. This product allows you to spread the overall cost of your Mercedes-Benz over a fixed term.

As a business customer, your vehicle can also appear as an asset on your balance sheet.

[For more information on Hire Purchase.](#)

Operating Lease

A solution for those who want to drive one of our vehicles over a specific term, with fixed monthly rentals and without the commitment of ownership of the vehicle.

As a business customer, your vehicle can also appear as an asset on your balance sheet.

[For more information on Operating Lease.](#)

Contract Hire

A solution for those who want to drive one of our vans over a specific term, with fixed monthly rentals and without the need to commit to ownership of the vehicle. This includes the cost of your Vehicle Excise Duty (also known as Road Fund Licence) for the duration of your agreement.

As a business customer, your vehicle can also appear as an asset on your balance sheet.

[For more information on Contract Hire.](#)

Finance Lease

Finance Lease gives you the ability to enjoy driving a Mercedes-Benz Van for a fixed time without the option of ownership. With this option you lease your vehicle for a fixed period and for fixed monthly rentals.

As a limited company or PLC customer, your vehicle can also appear as an asset on your balance sheet.

[For more information on Finance Lease.](#)

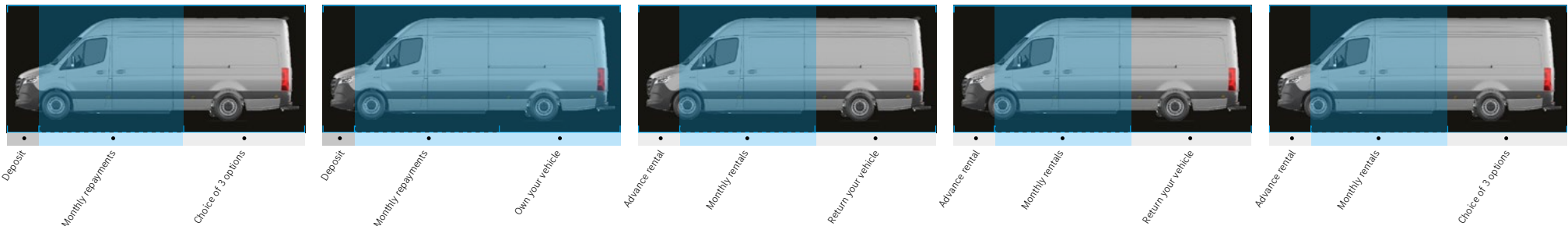

[For more information about our finance options](#)

Equipment (standard and optional overview).



RETURN TO START

Every eSprinter model comes with a host of standard features, plus a range of optional equipment and packages you can add to enhance your van.

Key: ● Standard ○ Optional — Not available

Category	Option Description	Option code	PRO	SELECT	Basic Price exc. VAT	Basic Price inc. VAT
Packages	Winter package Includes wet wiper system (FM3), seat heating for co-driver (H15) and heated seat for driver (H16)	F2W	○	○	£370.00	£444.00
	Winter Package Plus Includes wet wiper system (FM3), seat heating for co-driver (H15) and heated seat for driver (H16), Electrically powered hot-air auxiliary heater (HH2), Steering wheel heating (CK8), Heat insulation (H04); in combination with CL3 only	P3Z	○	○	£600.00	£720.00
	Maintenance package Includes 4 services: 2 Major and 2 Minor	JE1	●	●	—	—
Driver Assistance	Active Distance Assist DISTRONIC	ET4	○	○	£675.00	£810.00
	Blind Spot Assist	JA7	●	●	—	—
	Crosswind Assist	JA8	●	●	—	—
	Traffic Sign Assist	JA9	○	○	£350.00	£420.00
	Active Lane Keeping Assist	JB4	●	●	—	—
	Rain sensor	JF1	●	●	—	—
	Intelligent Speed Assistant	JS2	●	●	—	—
	Sideguard Assist	JT7	●	●	—	—
	ATTENTION ASSIST	JW8	●	●	—	—
	Comfort overhead control panel	LC4	●	●	—	—
	Cruise control	MS1	●	●	—	—
	Tyre pressure monitoring front/rear, wireless	RY2	●	●	—	—
	Acoustic speed warning, 80km/h	J62	○	○	£0.00	£0.00
	Speed limit 8 km/h, reverse gear	MA3	○	○	£170.00	£204.00
	Speed limiter, 100 km/h	MD2	○	○	£170.00	£204.00
Linear speed limiter 120 km/h Optional on N2 vans.	MD3	●	●	£170.00	£204.00	
Linear speed limiter 90 km/h EG Standard on N2 vans.	MD4	○	○	—	—	

Changes to individual option availability and combinations may occur depending on vehicle specification choices and the continuing evolution and adaptation of our product range. These changes may not be immediately reflected in this document as they occur, but will be introduced at the next revision opportunity.

Equipment (standard and optional overview).

● Standard ○ Optional — Not available



RETURN TO START

Category	Option Description	Option code	PRO	SELECT	Basic Price exc. VAT	Basic Price inc. VAT
Driver Assistance (cont.)	Speed limiter, 110 km/h	MK0	○	○	£170.00	£204.00
	Speed limiter, 80 km/h	MK5	○	○	£170.00	£204.00
	Intelligent tachograph, EU Standard on N2 vans.	JD6	○	○	£980.00	£1,176.00
	Controls for tachograph at front under roof liner Standard on N2 vans.	H1B	○	○	—	—
	Pre-installation, intelligent tachograph, EU	J4V	○	○	£430.00	£516.00
Heating and Ventilation	Thermally insulated load/passenger compartment	H01	○	○	£185.00	£222.00
	Heated seat for driver	H16	●	●	—	—
	Heat-insulating glass w.band filter on windscreen	H21	●	●	—	—
	Pre-entry climate control	H1K	●	●	—	—
	Energy-saving mode, climate control	H2K	○	○	£0.00	£0.00
	Electric roof fan II	H72	○	○	£575.00	£690.00
	Electrically powered hot-air auxiliary heater	HH2	●	●	—	—
	THERMOTRONIC automatic climate control	HH4	○	○	£545.00	£654.00
	TEMPMATIC Air conditioning, semi-autom. controlled	HH9	●	●	—	—
Audio Entertainment and Navigation	Tray for smartphones incl. wireless charging	E1B	○	○	£190.00	£228.00
	Digital radio (DAB)	E1D	●	●	—	—
	Navigation	E1E	○	○	£875.00	£1,050.00
	Smartphone Integration package Required for Apple CarPlay™ and Android Auto™ functionality	E4S	●	●	—	—
	MBUX multimedia system	E7M	●	●	—	—
	Pre-installation: Remote and Navigation Services	EW8	●	●	—	—
	Instrument cluster with colour display	JK5	●	●	—	—
	Acoustic package	XM4	●	●	—	—
Steering wheel	Multifunction steering wheel	C6L	●	●	—	—
	Height and rake adjustable steering wheel	CL1	●	●	—	—
	Leather steering wheel	CL3	○	●	£215.00	£258.00

Changes to individual option availability and combinations may occur depending on vehicle specification choices and the continuing evolution and adaptation of our product range. These changes may not be immediately reflected in this document as they occur, but will be introduced at the next revision opportunity.

Equipment (standard and optional overview).

● Standard ○ Optional — Not available



RETURN TO START

Category	Option Description	Option code	PRO	SELECT	Basic Price exc. VAT	Basic Price inc. VAT
Brakes	Electrical parking brake	B25	●	●	—	—
	Active Brake Assist	BA3	●	●	—	—
	HOLD function	BH1	●	●	—	—
	Wheel chock Standard on N2 vans.	Y26	○	○	£55.00	£66.00
	Adaptive brake light	LE1	●	●	—	—
	Hill-Start Assist	E07	●	●	—	—
Windows and Mirrors	Window front left, fixed, in sidewall/sliding door	W16	○	○	£200.00	£240.00
	Window front right, fixed, in sidew./sliding door	W17	○	○	£200.00	£240.00
	Sliding window front left in sidew./sliding door	W18	○	○	£470.00	£564.00
	Sliding window front right in sidew./sliding door	W19	○	○	£470.00	£564.00
	Fixed window, center left	W22	○	○	£200.00	£240.00
	Fixed window, center right	W23	○	○	£200.00	£240.00
	Sliding window center left	W24	○	○	£470.00	£564.00
	Fixed window, rear left	W27	○	○	£260.00	£312.00
	Fixed window at rear right	W28	○	○	£260.00	£312.00
	Sliding window rear left	W34	○	○	£470.00	£564.00
	Sliding window rear right	W35	○	○	£470.00	£564.00
	Window in tailgate/Rear hinged doors	W61	○	○	£245.00	£294.00
	Shaded glass in rear, black glass	W70	○	○	£0.00	£0.00
	Windscreen, heated	F49	○	○	£380.00	£456.00
	Rear mirror inside	F61	○	○	£65.00	£78.00
	Electrically foldable exterior mirrors	F64	●	●	—	—
	Exterior mirror heated and electr. adjustable	F68	●	●	—	—
	Digital rear-view mirror	F84	○	○	£770.00	£924.00
Exterior mirrors without indicators	FU5	○	○	£0.00	£0.00	

Changes to individual option availability and combinations may occur depending on vehicle specification choices and the continuing evolution and adaptation of our product range. These changes may not be immediately reflected in this document as they occur, but will be introduced at the next revision opportunity.

Equipment (standard and optional overview).

● Standard ○ Optional — Not available



RETURN TO START

Category	Option Description	Option code	PRO	SELECT	Basic Price exc. VAT	Basic Price inc. VAT
Battery	AGM battery, 12 V 70 Ah Optional on N2 vans.	ED1	●	●	£0.00	£0.00
	Heavy-duty battery Standard on N2 vans.	ED4	○	○	—	—
	Starting aid contact	ES0	●	●	—	—
Seating	Comfort driver's seat	SB1	○	●	£180.00	£216.00
	Comfort co-driver's seat	SB2	○	○	£180.00	£216.00
	Suspension seat, comfort version, driver's seat	SB3	○	○	£595.00	£714.00
	Suspension seat, comfort version, co-driver's seat	SB4	○	○	£595.00	£714.00
	Driver's seat plus	SB9	○	○	£30.00	£36.00
	Lumbar support, co-driver's seat	SE4	○	○	£95.00	£114.00
	Lumbar support, driver's seat	SE5	○	●	£95.00	£114.00
	Driver's seat electrically adjustable	SF1	○	○	£1,215.00	£1,458.00
	Co-driver's seat electrically adjustable	SF2	○	○	£1,215.00	£1,458.00
	Adjustable co-driver's seat	S04	○	○	£95.00	£114.00
	Armrest for driver's seat	S22	●	●	—	—
	Co-driver's double seat	S23	●	●	—	—
	Armrest for co-driver's seat	S25	○	○	£80.00	£96.00
	Armrest, driver's and co-driver's door	S28	○	○	£60.00	£72.00
	Convenience head restraint, driver's seat	SK0	○	●	£70.00	£84.00
	Convenience head restraint, co-driver	SK1	○	○	£140.00	£168.00
Co-driver's seat Not available on the 420 SELECT model.	SL1	○	○	£0.00	£0.00	

Changes to individual option availability and combinations may occur depending on vehicle specification choices and the continuing evolution and adaptation of our product range. These changes may not be immediately reflected in this document as they occur, but will be introduced at the next revision opportunity.

Equipment (standard and optional overview).

● Standard ○ Optional — Not available



RETURN TO START

Category	Option Description	Option code	PRO	SELECT	Basic Price exc. VAT	Basic Price inc. VAT
Electronics	USB socket, 5 V	E1U	●	●	—	—
	Plug socket in cab	E46	○	○	£75.00	£90.00
	Preinstallations electrical system, PSM	ED8	●	●	—	—
	Terminal strip for electrical connection	EK1	●	●	—	—
	12 V plug socket in trunk / load compartment	ES2	○	○	£75.00	£90.00
	Charging package, dashboard	ES5	○	●	£55.00	£66.00
Bulkhead	Full-length partition	D50	●	●	—	—
	Full-width partition with window	D51	○	○	£95.00	£114.00
Charging	Charging cable, mode 3 (type 2, 3x32A, 22kW), 5m	E2K	○	○	£430.00	£516.00
	Charging cable, mode 3 (type 2, 3x20A), 5m	E3K	○	○	£300.00	£360.00
	AC charging 22kW	E5A	○	○	£1,690.00	£2,028.00
	AC charging 11kW	E6A	●	●	—	—
	DC charging 115kW	E6J	●	●	—	—
	Charging cable, mode 3 (type 2, 3x20A), 8m	E8L	○	○	£345.00	£414.00
	Type 2 vehicle socket for electric vehicle	E96	●	●	—	—
	Charging cable, mode 3 (type 2, 3x32A), 8m	E9L	●	●	—	—
	Pre-install.: Remote and Charging Services Premium	EW5	●	●	—	—
Trim	All-weather floor mats	V3L	○	○	£60.00	£72.00
	Fabric Caluma black	VF4	○	○	£75.00	£90.00
	ARTICO man-made leather, black	VF6	○	○	£75.00	£90.00
	Fabric Maturin black	VF7	●	●	—	—
Keys	Two additional master keys	FZ9	○	○	£155.00	£186.00

Changes to individual option availability and combinations may occur depending on vehicle specification choices and the continuing evolution and adaptation of our product range. These changes may not be immediately reflected in this document as they occur, but will be introduced at the next revision opportunity.

Equipment (standard and optional overview).

● Standard ○ Optional — Not available



RETURN TO START

Category	Option Description	Option code	PRO	SELECT	Basic Price exc. VAT	Basic Price inc. VAT
Storage	Preinstallation for switch panel	E3J	●	●	—	—
	Mounting rails for roof rack	D13	○	○	£275.00	£330.00
	Coat hook in cab	F1K	●	●	—	—
	Shelf above windscreen	FF5	●	●	—	—
	Cup holders front	FG8	○	●	£40.00	£48.00
	Hinged lid for stowage compartment	FJ1	○	●	£120.00	£144.00
	Stowage compartment underneath cockpit	FJ4	●	●	—	—
	Hinged lid for stowage compartments left and right	FJ5	○	○	£130.00	£156.00
	Lockable unit in stowage compartment over windscreen	FQ6	○	○	£60.00	£72.00
Safety	First aid kit	Y10	○	○	£60.00	£72.00
	Fire extinguisher	Y16	○	○	£145.00	£174.00
	Warning triangle	Y44	○	○	£40.00	£48.00
	Warning lamp	Y45	○	○	£55.00	£66.00
	Airbag, front driver's seat	SA5	●	●	—	—
	Airbag, co-driver	SA6	●	●	—	—
	Thorax-pelvis sidebag, driver	SH1	○	○	£305.00	£366.00
	Thorax-pelvis sidebag, co-driver	SH2	○	○	£305.00	£366.00
	Windowbags for driver and co-driver	SH9	○	○	£880.00	£1,056.00
	Acoustic presence indicator	J2A	●	●	—	—
	Seat belt reminder for co-driver seat	J55	●	●	—	—
	Seat belt warning for driver's seat	J58	●	●	—	—
	Temperature indicator	J65	●	●	—	—
	Moving Off Information System Standard on N2 vans.	JF7	●	●	—	—
	Mercedes-Benz emergency call system	EY5	●	●	—	—
Breakdown management	EY6	●	●	—	—	

Changes to individual option availability and combinations may occur depending on vehicle specification choices and the continuing evolution and adaptation of our product range. These changes may not be immediately reflected in this document as they occur, but will be introduced at the next revision opportunity.

Equipment (standard and optional overview).

● Standard ○ Optional — Not available



RETURN TO START

Category	Option Description	Option code	PRO	SELECT	Basic Price exc. VAT	Basic Price inc. VAT
Wheels and Tyres	Spare wheel bracket below frame end	R65	●	●	—	—
	Spare wheel	R87	●	●	—	—
	Steel wheels, special paint finish	R98	○	○	£85.00	£102.00
	Full wheel cover	RD8	○	○	£85.00	£102.00
	Tyres 225/75 R16 C	RG8	●	●	—	—
	Light alloy wheels 6.5 J x 16	RL5	○	○	£1,035.00	£1,242.00
	All-season tyres	RM0	○	○	£0.00	£0.00
	Summer tyres	RM7	●	●	—	—
	Tyres, resistance-optimised	RR0	●	●	—	—
	Steel wheels 6.5 J x 16	RS3	●	●	—	—
	Hydraulic Jack	Y43	●	●	—	—
Axle	Front axle with upgraded axle load	A50	●	●	—	—
Suspension	Stabilisation level II	CB8	●	●	—	—
Roof	High roof H2	D03	●	●	—	—
Parking	Reversing camera	FR8	●	●	—	—
	Parking package with 360° camera	JB6	○	○	£1,590.00	£1,908.00
	Parking package with reversing camera	JB7	○	○	£1,165.00	£1,398.00
Grab handles	Grab handles for driver's and co-driver's doors	T75	○	○	£85.00	£102.00
	Grab handle at load comp.sliding door on partition	T77	●	●	—	—
	Entrance handle on LH rear corner pillar	T85	●	●	—	—
	Entrance handle on RH rear corner pillar	T86	○	○	£55.00	£66.00
Mud flaps	Front mud flaps	P47	○	●	£60.00	£72.00
	Rear mud flaps	P48	○	●	£60.00	£72.00

Changes to individual option availability and combinations may occur depending on vehicle specification choices and the continuing evolution and adaptation of our product range. These changes may not be immediately reflected in this document as they occur, but will be introduced at the next revision opportunity.

Equipment (standard and optional overview).

● Standard ○ Optional — Not available



RETURN TO START

Category	Option Description	Option code	PRO	SELECT	Basic Price exc. VAT	Basic Price inc. VAT
Loading & Towing	Sidewall tie-down rails on waist rail	V42	○	○	£440.00	£528.00
	Wheel arch, suitable for loading	V52	○	○	£460.00	£552.00
	Sidewall tie-down rails on roof frame	VC4	○	○	£420.00	£504.00
	Load securing rail system	VV2	○	○	£425.00	£510.00
	Rear cab wall lining	V07	●	●	—	—
	Sliding door right	T16	○	○	£1,260.00	£1,512.00
	Sliding door left	T19	●	●	—	—
	Electr. closing assist, sliding door right	T50	○	○	£430.00	£516.00
	Electr. closing assist, sliding door left	T51	○	○	£430.00	£516.00
	Rear doors, double-wing, opening to side wall	W54	●	●	—	—
	Rear door step	W73	●	●	—	—
	Wood flooring	V43	●	●	—	—
	Cable duct on side wall	V94	●	●	—	—
	Cable duct on rear portal	V95	●	●	—	—
	Full panelling, hinged rear doors	VA5	○	○	£50.00	£60.00
	Stow. comp. w. net in rear doors	VA7	○	○	£110.00	£132.00
	Floor covering, plastic	VK8	○	○	£0.00	£0.00
	Tensioning straps for tie-down rails	YK4	○	○	£95.00	£114.00
	Trailer coupling, rigid coupling head Not available on 420 SELECT models.	Q22	○	○	£665.00	£786.00
	Trailer coupling ball headed removable	Q50	○	○	£700.00	£840.00
Towing eye rear	Q67	●	●	—	—	
Trailer socket, 13-pin	E43	○	○	£270.00	£324.00	
Electrical components for trailer socket	E57	●	●	—	—	

Changes to individual option availability and combinations may occur depending on vehicle specification choices and the continuing evolution and adaptation of our product range. These changes may not be immediately reflected in this document as they occur, but will be introduced at the next revision opportunity.

Equipment (standard and optional overview).

● Standard ○ Optional — Not available



RETURN TO START

Category	Option Description	Option code	PRO	SELECT	Basic Price exc. VAT	Basic Price inc. VAT
Lighting	Lights for left hand traffic	L10	●	●	—	—
	Fog lamps with cornering light function	L13	○	○	£245.00	£294.00
	Front fog lamps	L16	○	—	£245.00	£294.00
	Reversing light, bottom	L21	●	●	—	—
	Partial LED tail lights	L22	○	○	£260.00	£312.00
	Directional indicators on front wings	L44	○	○	£135.00	£162.00
	Motion-sensor-controlled load comp. lighting	L71	○	○	£145.00	£174.00
	Highbeam Assist	LA1	○	●	£340.00	£408.00
	Headlight assistant	LA2	●	●	—	—
	Side marker lights	LB1	●	●	—	—
	3rd brake light	LB5	●	●	—	—
	Exit lamps	LB9	○	○	£105.00	£126.00
	LED light strip in load compartment	LC2	○	○	£325.00	£390.00
LED High Performance headlamps	LG7	○	●	£1,760.00	£2,112.00	

Colours and upholstery.



RETURN TO START

Solid paints

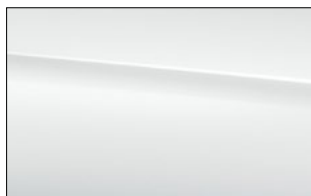

Arctic White
(Standard on the eSprinter panel van)

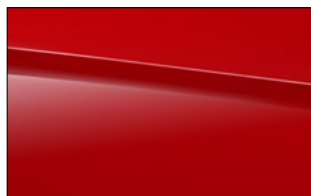

Jupiter Red



Steel Blue

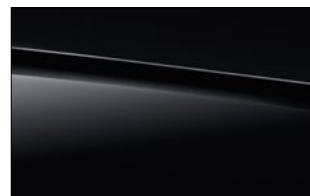

Jet Black

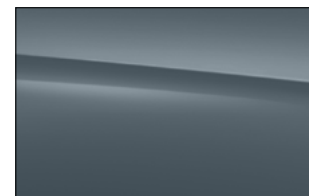

Blue Grey

Metallic paints



Tenorite Grey Metallic

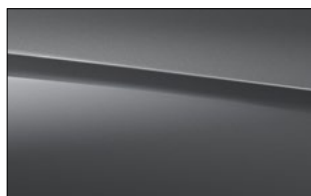

Selenite Grey Metallic

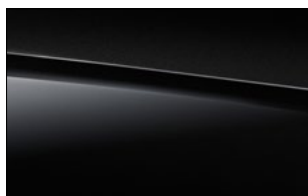

Obsidian Black Metallic

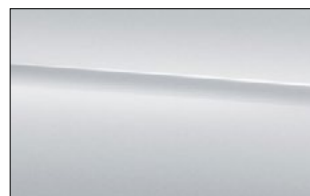

High Tech Silver Metallic

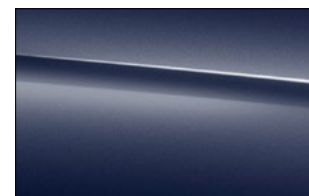

Cavansite Blue Metallic

Interior upholstery

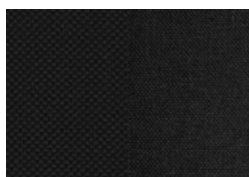

Maturin Black Fabric
seat upholstery

Due to limitations of on-screen representation, the vehicle colours may differ in reality to the on-screen images.

Wheels.



RETURN TO START

A. 40.6 cm (16-inch) steel wheels (RS3)

Standard on eSprinter Panel Van



B. 40.6 cm (16-inch) full wheel cover (RD8)

Optional



C. 40.6 cm (16-inch) 6-spoke light-alloy wheels (RL5)

Optional



Charging Information.

Increasing efficiency and reducing downtime.

› The eSprinter can be charged by Direct Current (DC) or Alternating Current (AC).

AC is usually found at homes and workplaces and more cost effective for charging, however, generally requires longer intervals to fully charge. DC power can rapid-charge an electric vehicle using higher charging powers. For example, the eSprinter can accept 115kW of power.

- AC 7kW: 0-100% in ~12h 30 min†
- AC 11kW 0-100% in 8h 30 min (Wallbox)†
- AC 22kW 0-100% in 4h 30 min (Wallbox)†
- DC 115kW 10-80% in just 34 minutes†.

› Managing range and battery performance.

The eSprinter uses a process called recuperation that recovers energy when the vehicle is decelerating to help recharge the vehicle's battery. There are 5 recuperation modes available, which can be adjusted via the steering-wheel paddles. The greater the recuperation level, the faster you decelerate and therefore, the more energy your vehicle will recover. An automatic mode is also fitted as standard, D AUTO, which uses the radar-sensor to intelligently select the best mode for a given driving situation.

- D-** This mode will enable you to get maximum range from your eSprinter. It has maximum recuperation and fastest deceleration. Due to the deceleration being so strong, your vehicle will automatically activate your brake lights when you lift off the accelerator.
- D** This mode has less recuperation than D- and has similar deceleration levels to a diesel Sprinter.
- D+** This mode has significantly lower recuperation levels and therefore will decelerate at a slower rate than a diesel Sprinter. D+ is a coasting mode, meaning your vehicle will have no recuperation and can 'sail' for example when driving for long periods downhill.
- D++** No recuperation and slowest deceleration.

† Charging times are for the 81kWh eSprinter vans. Charging times are subject to the power available at the location where the vehicle will be charged as well as factors such as temperature, charge point and type of cable used.

^ Mercedes-Benz research analysed 1.6 million journeys anonymously on the EQ Ready app and 96% of all journeys recorded were shorter than 100km (62 miles).



Did you know the average van across the UK and Europe travels less than 62 miles[^] a day?

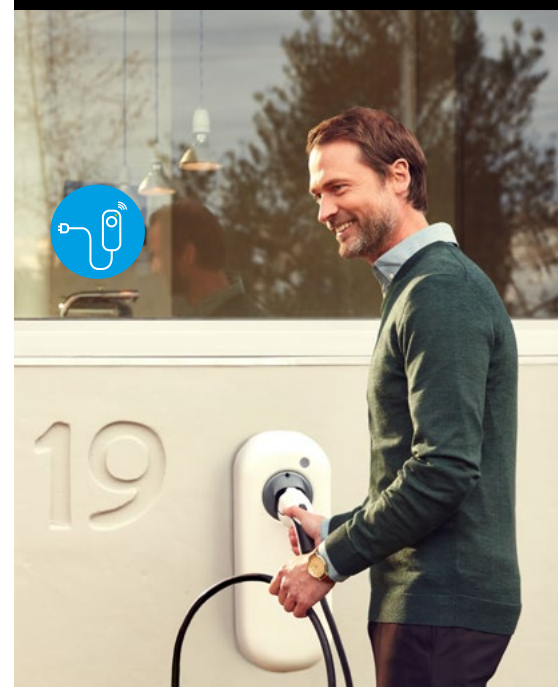

The New Mercedes-Benz eSprinter

Technical Data - Battery and e-Motor.



RETURN TO START

System specifications

Fuel	Electric
Output, max.	100kW
Output, max.	136 PS
Torque, max.	400 Nm
Drive	RWD
Battery Composition	LFP (Lithium iron phosphate)
Battery Capacity	81kWh / 113kWh
Battery Voltage	400
Battery Charging	AC: 11kW / AC: 22kW / DC: 115kW
Battery Charging Time	113kWh: AC (11kW) 0-100% - 11:15 (wallbox)/ AC (22kW) 0-100% - 06:00 (wallbox)/ DC (115kW) 10-80% - 42 min 81kWh: AC (11kW) 0-100% - 08:30 (wallbox)/ AC (22kW) 0-100% - 04:30 (wallbox)/ DC (115kW) 10-80% - 34 min
Service Interval	1 year/24,000 miles
Battery Capacity Warranty	8 years/100,000 miles

System specifications

Fuel	Electric
Output, max.	150kW
Output, max.	204 PS
Torque, max.	400 Nm
Drive	RWD
Battery Composition	LFP (Lithium iron phosphate)
Battery Capacity	81kWh / 113kWh
Battery Voltage	400
Battery Charging	AC: 11kW / AC: 22kW / DC: 115kW
Battery Charging Time	113kWh: AC (11kW) 0-100% - 11:15 (wallbox)/ AC (22kW) 0-100% - 06:00 (wallbox)/ DC (115kW) 10-80% - 42 min 81kWh: AC (11kW) 0-100% - 08:30 (wallbox)/ AC (22kW) 0-100% - 04:30 (wallbox)/ DC (115kW) 10-80% - 34 min
Service Interval	1 year/24,000 miles
Battery Capacity Warranty	8 years/100,000 miles



[RETURN TO START](#)

Technical Data - WLTP Range, CO₂ emissions and Electrical Consumption.

All-electric WLTP Range (mi/km)	CO ₂ emissions, combined, (g/km)	Combined	Low (extra-urban)	Medium (urban)	High (rural)	Extra-high (motorway)
81kWh eSprinter 314 Van L2 PRO	0	165/266	TBC	TBC	TBC	TBC
81kWh eSprinter 320 Van L2 PRO	0	167/268	TBC	TBC	TBC	TBC
81kWh eSprinter 320 Van L2 SELECT	0	167/268	TBC	TBC	TBC	TBC
81kWh eSprinter 314 Van L3 PRO	0	161/259	TBC	TBC	TBC	TBC
81kWh eSprinter 320 Van L3 PRO	0	162/260	TBC	TBC	TBC	TBC
81kWh eSprinter 320 Van L3 SELECT	0	161/259	TBC	TBC	TBC	TBC
81kWh eSprinter 414 Van L2 PRO	0	183/294	TBC	TBC	TBC	TBC
81kWh eSprinter 420 Van L2 PRO	0	185/297	TBC	TBC	TBC	TBC
81kWh eSprinter 414 Van L3 PRO	0	177/285	TBC	TBC	TBC	TBC
81kWh eSprinter 420 Van L3 PRO	0	178/286	TBC	TBC	TBC	TBC
113kWh eSprinter 414 Van L3 PRO	0	272/438	TBC	332/534	TBC	TBC
113kWh eSprinter 420 Van L3 PRO	0	269/433	TBC	331/532	TBC	TBC
113kWh eSprinter 420 Van L3 SELECT	0	268/432	TBC	330/531	TBC	TBC

The indicated values were determined according to the prescribed measurement method - Worldwide Harmonised Light Vehicle Test Procedure (WLTP). Battery Electric Vehicles (BEV) require mains electricity for charging, range figures determined with the battery fully charged. Figures shown are for comparability purposes; only compare with other cars tested to the same technical procedure (WLTP). Figures may not reflect real life driving results, which will depend upon a number of factors including the starting charge of the battery, factory-fitted options, accessories fitted (post registration), variations in weather, driving styles and vehicle load. Further information about the test used to establish range, power consumption and CO₂ figures can be found at <http://www.mercedes-benz.co.uk/WLTP>. For real time data visit https://voc.mercedes-benz.com/voc/gb_en.

[RETURN TO START](#)

Technical Data -WLTP Range, CO₂ emissions and Electrical Consumption.

Electrical consumption (kWh/100km)	CO ₂ emissions, combined, (g/km)	Combined	Low (extra-urban)	Medium (urban)	High (rural)	Extra-high (motorway)	Wh/km
81kWh eSprinter 314 Van L2 PRO	0	33.6	21.0	24.1	29.8	49.1	336
81kWh eSprinter 320 Van L2 PRO	0	33.2	20.6	23.6	30.0	45.9	331
81kWh eSprinter 320 Van L2 SELECT	0	33.3	20.6	23.6	30.0	45.9	332
81kWh eSprinter 314 Van L3 PRO	0	34.6	22.1	25.3	30.7	49.6	344
81kWh eSprinter 320 Van L3 PRO	0	34.3	21.7	24.8	31.0	46.8	341
81kWh eSprinter 320 Van L3 SELECT	0	34.4	21.8	24.9	31.1	46.9	342
81kWh eSprinter 414 Van L2 PRO	0	29.2	21.0	24.3	29.5	35.2	292
81kWh eSprinter 420 Van L2 PRO	0	29.0	21.2	24.1	29.5	33.4	289
81kWh eSprinter 414 Van L3 PRO	0	30.6	22.6	26.0	30.9	36.0	292
81kWh eSprinter 420 Van L3 PRO	0	30.5	22.8	25.8	31.0	34.5	304
113kWh eSprinter 414 Van L3 PRO	0	28.0	20.6	23.5	28.6	32.7	279
113kWh eSprinter 420 Van L3 PRO	0	29.2	21.0	24.0	30.2	34.0	291
113kWh eSprinter 420 Van L3 SELECT	0	29.3	21.1	24.1	30.3	34.1	291

The indicated values were determined according to the prescribed measurement method – Worldwide Harmonised Light Vehicle Test Procedure (WLTP). Battery Electric Vehicles (BEV) require mains electricity for charging, range figures determined with the battery fully charged. Figures shown are for comparability purposes; only compare with other cars tested to the same technical procedure (WLTP). Figures may not reflect real life driving results, which will depend upon a number of factors including the starting charge of the battery, factory-fitted options, accessories fitted (post registration), variations in weather, driving styles and vehicle load. Further information about the test used to establish range, power consumption and CO₂ figures can be found at <http://www.mercedes-benz.co.uk/WLTP>. For real time data visit https://voc.mercedes-benz.com/voc/gb_en.

Technical Data – Payload and Weights.



RETURN TO START

Model	Kerb weight, with driver (Kg)*	Gross Vehicle Weight (Kg)	Payload (Kg)	Gross Combination Weight (Kg)
81kWh eSprinter 314 Van L2 PRO	2854	3500	646	5000
81kWh eSprinter 320 Van L2 PRO	2854	3500	646	5000
81kWh eSprinter 320 Van L2 SELECT	2861	3500	639	5000
81kWh eSprinter 314 Van L3 PRO	3003	3500	497	5000
81kWh eSprinter 320 Van L3 PRO	3003	3500	497	5000
81kWh eSprinter 320 Van L3 SELECT	3010	3500	490	5000
81kWh eSprinter 414 Van L2 PRO	2877	4150	1273	5000
81kWh eSprinter 420 Van L2 PRO	2877	4150	1273	5000
81kWh eSprinter 414 Van L3 PRO	3026	4250	1224	5000
81kWh eSprinter 420 Van L3 PRO	3026	4250	1224	5000
113kWh eSprinter 414 Van L3 PRO	3247	4250	1003	5000
113kWh eSprinter 420 Van L3 PRO	3247	4250	1003	5000
113kWh eSprinter 420 Van L3 SELECT	3254	4250	996	5000

All weights and dimensions quoted are subject to normal manufacturing tolerances of +/- 5%. Stated weight figures in accordance with Directive 97/27/EC in the applicable version at the time of going to print. Stated weight figures are for UK supplied vehicles and include charging cable and all standard equipment. The figures are not based on an individual vehicle and do not constitute part of the product offer; they are provided solely for the purposes of comparison between different vehicle models. The payload figures depend on the optional equipment fitted to the vehicle, please contact your Mercedes-Benz Retail Partner for an individual vehicle calculation. Payload figures include the standard mode3 charging cable (5kg).

Dimensions.



RETURN TO START

PANEL VAN - PRO/SELECT L2*

Wheelbase	Wheelbase length	3,665mm
	Turning circle	13.4m
	Front track width	1,726mm
	Rear track width	1,732mm
Vehicle	Length (inc. tread)	5,932mm
	Height (unladen)	2,718mm
	Width (inc. wing mirrors)	2,345mm
	Ground clearance	193mm
Load compartment	Length	3,375mm
	Load volume	9m ³
	Max. width	1,787mm
	Width between wheel arches	1,350mm
	Height	2,009mm
Gross Vehicle Weight (GVW)		3,500kg

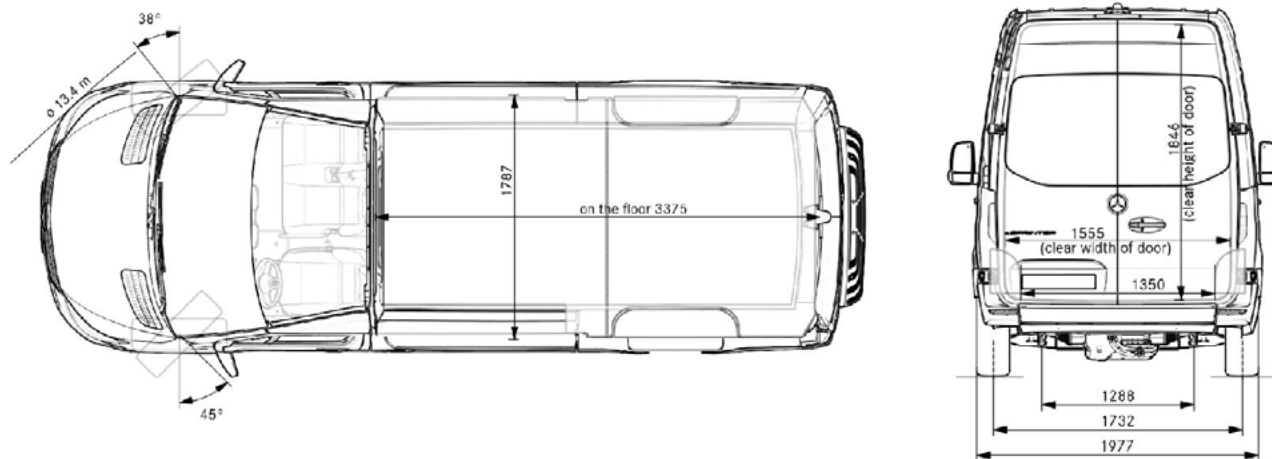
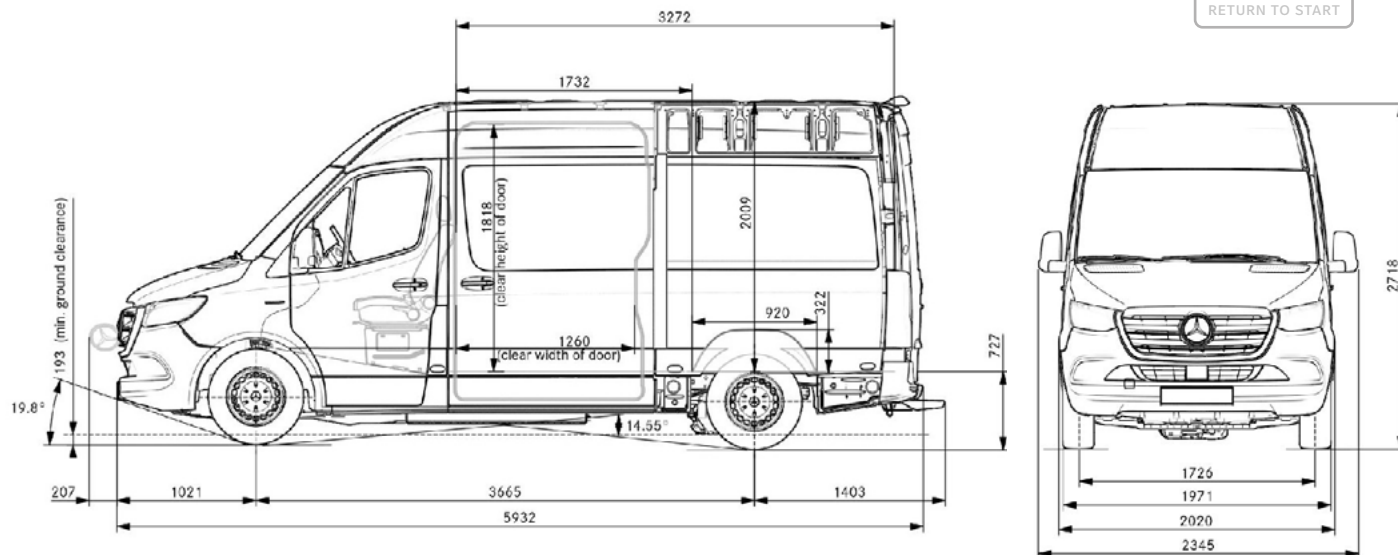

*Dimensions could vary according to variant, please consult your local dealer.

Dimensions.



RETURN TO START

PANEL VAN - PRO/SELECT L3*

Wheelbase	Wheelbase length	4,325mm
	Turning circle	15.3m
	Front track width	1,726mm
	Rear track width	1,732mm
Vehicle	Length (inc. tread)	7,124mm
	Height (unladen)	2,720mm
	Width (inc. wing mirrors)	2,345mm
	Ground clearance	164mm
Load compartment	Length	4,410mm
	Load volume	14m ³
	Max. width	1,787mm
	Width between wheel arches	1,350mm
	Height	2,009mm
Gross Vehicle Weight (GVW)		4,250kg

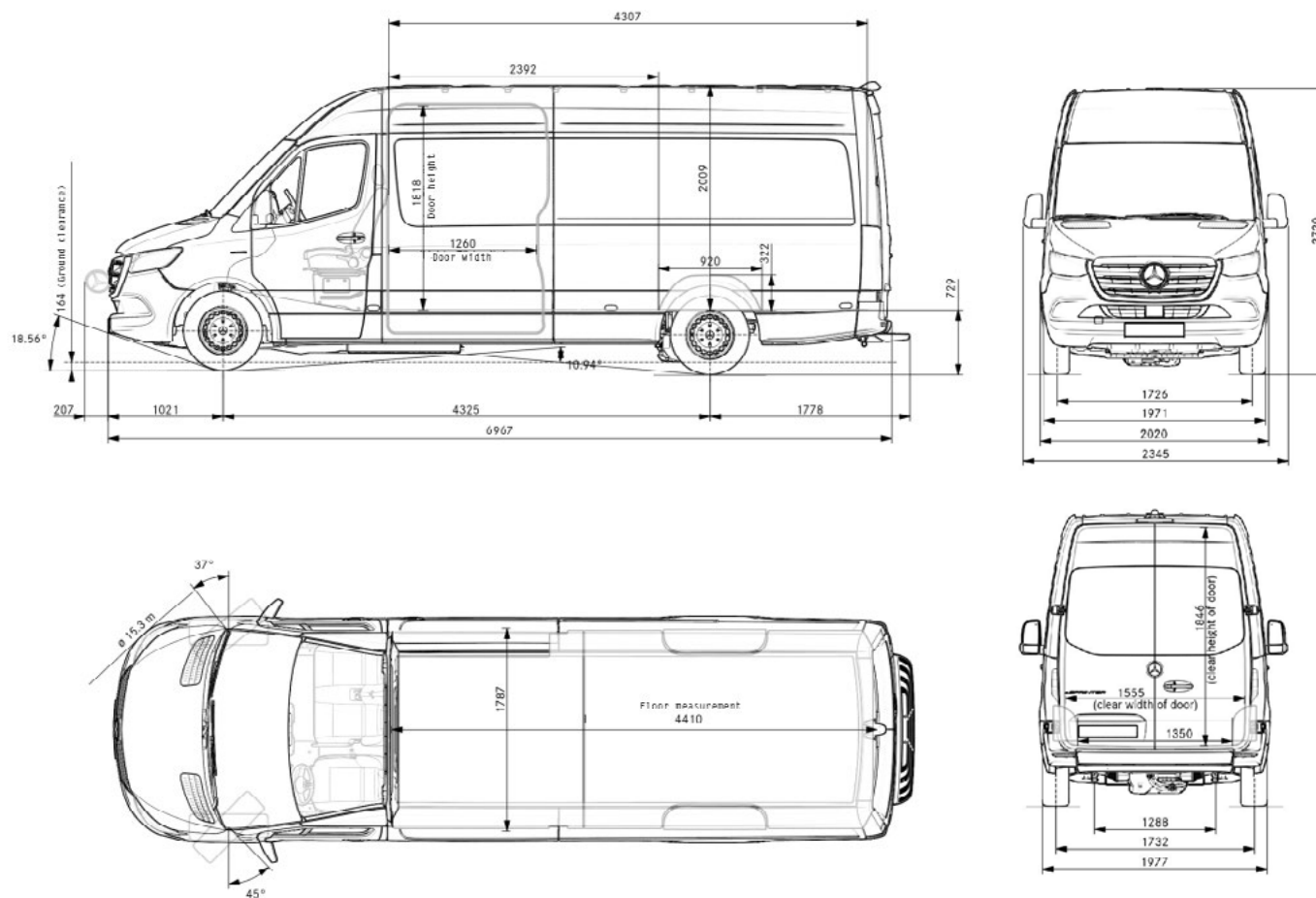

*Dimensions could vary according to variant, please consult your local dealer.

Mercedes-Benz Electric Vans and the Environment.



RETURN TO START

A key advantage of any battery electric vehicle (BEV) is its positive environmental impact, compared to an internal combustion (ICE) vehicle. Mercedes-Benz electric vans produce no tailpipe emissions.

See right for the Energy Efficiency Rating and emission standards compliance.

Environmental data, Mercedes-Benz electric vans

CO₂ is the main greenhouse gas responsible for climate change.

0	A	Rating: A 0g/km
1-50	A	
51-75	B	
76-90	C	
91-100	D	
101-110	E	
111-130	F	
131-150	H	
151-170	I	
171-190	J	
191-225	K	
226-255	L	
256+	M	

ULEV ✓
Ultra Low Emission Vehicle **ULEV**

ZEV ✓
Zero Tailpipe Emissions Vehicle **ZEV**

ULEZ ✓
Clean Air Zones
(England and Wales) **CAZ**

ULEZ ✓
Ultra Low Emission Zone
(London) **ULEZ**

This vehicle(s) meets the emissions standard for private vans set by government under the Clean Air Zone (CAZ) framework for England and Wales currently in place until 2025. Stricter CAZ standards and restrictions could then apply. Some local authorities may also impose more stringent controls in certain areas. A ULEV meets the current government standard for an Ultra Low Emission Vehicle, stricter standards could apply in the future. See more about future CAZs [here](#).

Ambition 2039

A core element of our sustainable business strategy is Ambition 2039, with which we already set the course in 2019 for a holistic approach to climate protection and air pollution control.

The ambition is to make our entire fleet of new vehicles net carbon-neutral along the entire value chain and over the vehicles' entire life cycle by 2039 – from development to the supplier network, in-house production, electrification of products to renewable energies in the use phase of electric vehicles and recycling of the vehicles to close the loop.



The Mercedes-Benz App on new eSprinter.



RETURN TO START

Monitor your van's status, location and security via your smartphone.



ASSISTANCE & AFTERCARE		FREE
Telediagnosics & Maintenance Management	Receive a notification when wear is detected on diagnostic-capable parts such as brake pads and get advance notice of when a service is due allowing you to plan your workshop visit well in advance to minimise any impact on your business.	
Remote Vehicle Diagnostics	Your Dealer can assess your van's condition remotely allowing them to check if any other repairs are required ahead of a service.	
Accident Recovery & Breakdown Management	Once an emergency call has been resolved or if you request breakdown assistance, further support is offered to help recover your van or to tow it to a Mercedes-Benz Service outlet.	
Software updates	Over-the-air software updates are sent directly to your van's head unit. This means you'll always know your software is up to date and you'll save time by avoiding additional workshop visits.	
VEHICLE SUPERVISION		FREE FOR 3 YEARS
Vehicle Tracker	See your van's location on the map in your app, making it easy to call or message your driver and re-route them to fit in another delivery or pick-up if a quicker route is available. The tracker is factory fitted equipment so it can't be easily removed if stolen.	
Parked Vehicle Locator	If you're within 1 mile of your van's parked location, the app can generate the most convenient walking route - very handy if you're in unfamiliar surroundings and on a busy schedule.	
REMOTE ACCESS		FREE FOR 3 YEARS
Remote Retrieval of Vehicle Status	Use your app to check on charge level, tyre pressure, mileage and trip information. Not only does this help you plan your day's journeys, it can save you admin time on tasks such as logging your mileage for expenses.	
Remote Door Locking & Unlocking	The app allows you to check if your van is locked. If you lock your keys in the van or need to give another driver access, you can do it via the app, from any distance away. For added peace of mind, you'll receive an email notification when your vehicle is unlocked.	
EV SERVICES		FREE
Pre-Entry Climate Control	Climate control can be started remotely when your van is charging so energy used for heating will draw on the mains power to avoid depleting your battery. This means you'll have maximum comfort and battery range.	
Display of Charging Stations & Range on map	The Mercedes-Benz App shows you charging stations in the surrounding area and enables you to set the preferred one as your destination. The range display in your app helps you plan a journey with confidence as it shows if you can reach your destination using your existing battery range.	

Mercedes-Benz Approved Used Electric vans. Get used to more...

More choice. More confidence. More quality – and more added extras.

As a Mercedes-Benz Approved Used Electric customer, you'll have complete peace of mind as every van offers the same commitment to quality and workmanship as new and comes with:



12-24 month warranty option*



Free MOT test failure cover**
covering you for £1,500

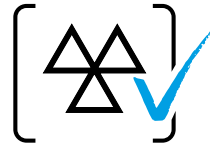

Minimum
3 months MOT



Free 24/7 breakdown cover
and roadside assistance^



Comprehensive
multi-point vehicle check

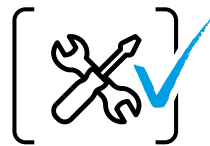

Discounted
service plans

*Warranty eligible up to 200,000 miles on approved used Mercedes-Benz Vans with less than 150,000 miles at point of sale. For full T&Cs, please speak to your preferred sales representative. ** MOT cover redeemable per 12-months warranty. £1,500 claims limit. For more information, please speak to your preferred sales representative. ^ Free for 12 months initially and renewed at each service, if serviced by MB according to service intervals for up to 30 years from when the vehicle was first registered. For a full list of exclusions and all product terms please visit mbvans.co.uk/mobilovan For full terms and conditions, please consult your local Dealer. Mercedes-Benz Van Insurance is a trading name of Mercedes-Benz Insurance Services UK Limited. Prices are correct at time of going to press 02/2025. All prices are subject to any fiscal or legislative changes.



RETURN TO START

Approved
Used
Electric



What is an Approved Used van?

- Is no older than 6 years old
- Has less than 150,000 miles on the clock
- Is eligible for one of our flexible finance plans

➤ [Find more information and our latest Approved Used Electric offers](#)

What is an Approved Used Electric van?

➤ [Visit our Dealer Networks Approved Used Electric van stock](#)

The New Mercedes-Benz eSprinter

30



RETURN TO START

All eSprinter models will include an Integrated Service Package (ISP).

Integrated Service Package (ISP), helps to form an integral part of our commitment that the eSprinter is not only performing well but is safe to operate at all times.

Our ISP consists of four services: two A (minor) and two B (major) services as standard – and can be transferred to a new owner. All of our electric vehicles also come with out of charge cover and an 8year/100,000 miles battery capacity warranty as standard.



Service24: Demand more.

The most comprehensive Aftercare package – for businesses that demand more.

Our 120-strong Dealer network works around the clock to service and maintain your vans and keep your business moving. It all adds up to more value, more flexibility and more confidence that you'll only find at an authorised Mercedes-Benz Dealer.



› Flexible servicing and maintenance

Book your service online or by telephone, and as well as a standard 'drop and go' service with a courtesy van, you'll also get:

- Early bird, late night and weekend slots
- Mobile service
- Overnight service
- Collect & deliver service
- Express 1hr service
- Electric van service.

[Find out more about service and repairs](#)



› Flexible ways to pay and save

With fixed, transparent national pricing there are no surprises with our services and repairs – plus you can fix, spread and reduce your service and maintenance costs, and ease your cashflow at the same time, with a payment plan.

- Pay as You Go
- ServiceCare Maintenance
- ServiceCare Complete.

[Find out more about service options](#)



› 3-year unlimited mileage warranty

Available on every new van, all service and maintenance – and any work required – is covered by your 3-year unlimited mileage warranty, and is only undertaken by Mercedes-Benz trained technicians using Mercedes-Benz GenuineParts.

› 8 year/100,000 mile Battery Capacity Warranty

For peace of mind and reliable performance, the eSprinter's battery comes with an impressive 8 year/100,000 mile battery guarantee.

[Find out more about warranties](#)



› Free breakdown cover & roadside assistance*

Every van comes with free Europe-wide breakdown cover – MobiloVan. And with 3 years' cover on new vehicles for driver mishaps, no one goes further to keep your business moving.

- Trained technicians using only Mercedes-Benz GenuineParts
- Out of charge cover for electric vehicles
- Forward travel of load and crew is covered
- Driver mishap cover for the first 3 years, including out of charge cover or empty fuel tanks.

[Find out more about MobiloVan](#)

*For a full list of exclusions and all product terms please visit www.mercedes-benz.co.uk/vans/en/Owners/MobiloVan

The New Mercedes-Benz eSprinter

32

